

System 354 62 799

=> [€/€](#)

**6 Volts generator/electronic ignition
for [JAWA and CZ Twins](#)**  (JAWA
18/354/360/361/362/633)

The 6 Volts system doesn't support the charge control light (the recommended [12 Volts system 354 61 799](#) does)!



Magnet based generator with integrated fully electronic ignition. Output 6V/100W DC. Solid state ignition with own power supply from within the system. Replaces old dynamo, points, condenser, ignition coils. You may [drive without a battery](#), if you want. There is no need for changes on engine casing.

advantage over original system

- all parts are new
- more light output
- very stable ignition with solid spark
- better starting, better fuel burning
- no huzzle anymore with setting points

documentation

- [assembly instructions](#)
- [wiring diagram](#)
- [parts in the pack \(foto\)](#)
- [information on driving without battery](#)
- [supplement for JAWA mit amperemeter](#)

photos

- [JAWA during installation of the system](#)
- [closer view at the new system in the engine](#)
- [the new ignition coil on the bike](#)
- [the new regulator on the bike](#)
- [position of the new stator on the engine](#)

assembly instructions for [system 354 62 799 00](#)

Version 12.11.2013

Please take note: All of our 6 Volt systems includes no charge control!

Please check first whether you have one of those first JAWA where the plus-pole of the battery is connected to the frame. If so, please do reverse **battery polarity** when you put the accumulator back again after assembly of the new system. Ground has to be connected to the minus-pole of the battery and the plus-pole to pin 30 of the ignition lock. If you do not observe this, your new regulator will be burned.

INFO

For Perak and other JAWA/CZ with **amperemeter** please see [additional information](#).

If you can install and time a stock ignition and possess basic mechanical skills, you can install a VAPE system!

If you never have worked on your ignition, better have it done by someone who knows.

VAPE can not monitor the compliance to those instructions, nor the conditions and methods of installation, operation, usage and maintenance of the system. Improper installation may result in damage to property and possibly even bodily injury. Therefore we assume no responsibility for loss, damage or cost which result from, or are in any way related to, incorrect installation, improper operation, or incorrect use and maintenance. We reserve the right to make changes to the product, technical data or assembly and operating instructions without prior notice.

**IMPORTANT:****Please read these instructions fully and carefully before starting work on your motorcycle**

Please bear in mind that [any modification of the material as well as own repair attempts which have not been agreed with VAPE may result in a loss of warranty. Do not cut off wires. This leads to a loss of reverse polarity protection and often results in damage to electronics.](#)

Also, please take note of the information provided on the information page for this system. Check that what you have bought really corresponds to the motorcycle you have. Wrong ignition settings may damage your engine and even hurt you during kickstart (violent kickbacks). Be careful during the first test runs. If needed change settings to safer values (less advance). During assembly check carefully that the [rotor \(flywheel\) does not touch the stator coils or anything else](#), which may happen due to various circumstances and lead to severe damage.

Designated use

This system is designated to replace stock dynamo/alternator & ignition systems in vintage and classic motorcycles [whose engine characteristics have not been modified aftermarket](#). This system is not a tuning system and it will not bring significant increases in engine output. It does however significantly enhance roadworthiness and comfort by offering better lighting, better function of side indicators and horn and, compared with the aging stock systems, increased reliability. As our system does not tamper with engine characteristics it does not increase emission of gaseous pollutants and noise. In most

cases emission of pollutants should even be reduced due to better combustion. If used as designated the system therefore will not normally infringe the existing legal status of the motorcycle (this statement is valid for Germany, for other countries, please check locally against your road licensing regulations). This system is not suitable for use in competition events. If used other than the designated way, warranty will be voided and it might well be that you do not obtain the desired results or, worst you lose legal roadworthiness.

The charging system is only suitable for use with rechargeable 12V (6V systems 6V) lead-acid batteries with liquid electrolyte or sealed lead-acid batteries, AGM, Gel. [It is not suitable for use with nickel-cadmium, nickel-metal-hydride, lithium-ion or any other types of rechargeable or non rechargeable batteries.](#)

This is a **[replacement system and not a copy of the stock material](#)**. The parts in this system therefore look different and might fit differently (notably ignition coil and regulator) requiring some adaptation by you.

During assembly imperatively start with assy of engine based parts to see that those really fit before you start fitting the external parts. In many cases customers assemble those first and thereby often [modify them in breach of warranty](#) which renders them unfit for renewed sale. [Replacing old ignition systems is not a matter of taking something from a supermarket shelf as there have been very many types, versions and possibly unknown aftermarket modifications which harbour plenty of room for error.](#)

Our systems are **[NOT tested for use with third party electronic devices \(such as GPS, mobile phones, LED lighting etc\) and may cause damage to such parts.](#)** Possibly existing [electronic tachometers](#) will not work with the new system. Read our [information for suitable solutions](#). Possibly existing safety switches and electronic valve controls are not supported. It might be that your motorcycle was originally equipped with an ignition that did limit top speed for legal reasons. The new system does not have such a facility, so check your legal situation beforehand.

If you have no expertise for the installation have it done by an expert or at a specialist's workshop. Improper installation may damage the new system and your motorcycle, possibly even lead to bodily harm.

Before you order a system, please check whether a [puller tool](#) for the new rotor is included in the kit. If not, better order it at the same time. You might want to order light [bulbs](#), [fuse](#), horn, [flasher unit](#) etc. Never use anything other than the recommended puller tool to pull

the new rotor again. Damage to the rotor as a result of use of other tools or methods is not covered by warranty.

The rotor is sensible to blows (including during transport). Before assembly, please always check for damage (on rotor without magnet plastification try to push the magnets aside with your fingers). After impact the glued in magnets might have broken loose, sticking to the rotor solely by magnetic force, so that one does not notice right away. During engine run the damage would be considerable. Before placing the rotor onto the engine, please make sure that its magnets have not collected any metal objects such as small screws, nuts and washers. That equally would lead to severe damage.



Internet

If you have access to the Internet, best view those instructions online. You get larger and better pictures by clicking onto them and possibly updated information. System list at <http://www.powerdynamo.biz>



You should have received those parts!

Please observe that the stator coil is only loosely mounted to the base plate at time of delivery as you will have to disengage it during assembly (otherwise you will not get the fastening screws to the crank case fitted).

Please observe further that the sensor (pickup) is only loosely mounted by us, as you have to set its gap. Tighten the screws carefully after setting.



To pull the new rotor again, you will need a puller tool M27x1,25 (part-no.: 99 99 799 00 - **Not provided!**).

Note: Never use a claw puller, a hammer or any other device, that will shake the magnets off.



To pull the old rotor, you will need a puller tool M8x90 (part-no.: 70 80 899 90 - **Not provided!**).

Notes on wiring:

Experience shows that in the course of time nearly every motorcycle undergoes changes to its wiring. As a result, wire colours and wires themselves on your bike might differ to those we describe. In case of doubt, please consult the original wiring diagrams for MZ (e.g. on www.ostmotorrad.de).

Wiring of our system is nearly the same for all JAWA/CZ with formerly 6Volt dynamos. A little different is this only for bikes which had an ampmeter/switch combination in the tank. For those [see special information on Perak](#).

Disconnect your battery and take it out of the motorcycle. Note that should you be installing a 12 volt system, you will either need a 12 volt battery or you use the option of driving without. You will still have to replace all lightbulbs to 12 volt ones however in that case too. The horn may stay at 6 volts. For [driving without battery](#), please observe our [information on driving without battery](#).

Decide what sort of switch off method you want to install. There are two options, each with its advantages and disadvantages. We have pre-assembled the relay option.

relay method (supplied as standard)

advantage: This option will allow you to use your ignition switch as before. Nothing changes

disadvantage: You cannot ride without a working battery. (Unless, in an emergency you pull the brown wire bringing earth to the relay so that it has no longer contact to earth.)

kill switch method

advantage: You may drive without battery, a plus for historic bikes driven only occasionally.

Disadvantage: You have to buy the switch and you need to install it on the handlebar. We offer such a switch.

Tip: You may re-function the flashlight switch to do the job.

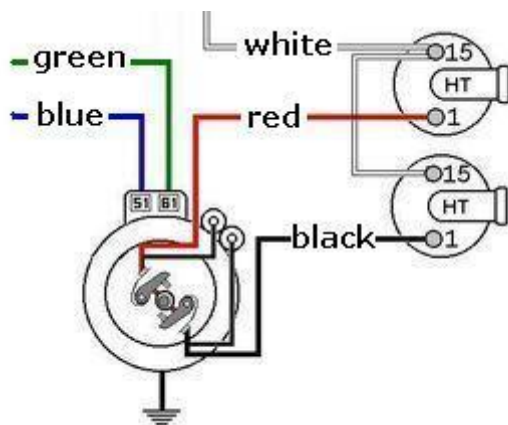

Disconnect all cables from your old generator, regulator and the ignition coils and remove those parts. You may pull your old rotor from the crankshaft by means of a puller screw M8x90.

Check whether the neutral gear wire had been running through the pieces of harness you are going to remove. If so, it will get removed and you will have to install a new one.

Pay attention:

- The blue wire, that did run from pin 30 of the main switch to pin 51 of the old dynamo, will be needed again.
- The green wire, that went to pin 61 (or D) of the old regulator, will be used by our 12 volts systems.
- The white wire, running to the old ignition coils, will be used too.
- Remove the black and the red wires, running from the contact breakers to the old ignition coils. They will not be needed anymore.

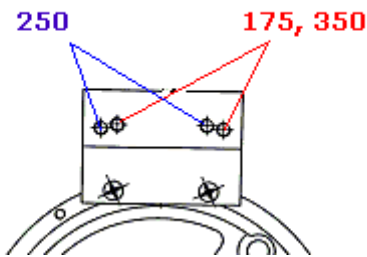

Check at the new baseplate the position of the sensor (pick-up) at the rectangular plate. There are 2 possible mounting positions.

For the **350cc** the sensor will be positioned to the RH side (we pre-assemble this as default).

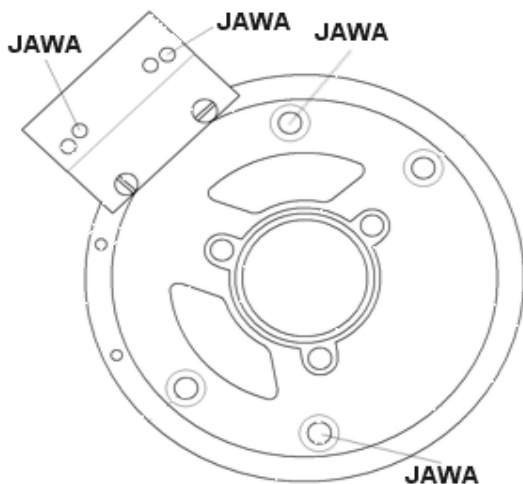

Unscrew the stator coil from the base plate and lift it a little away from it so that you can access the mounting holes. Take care not to damage the paint insulation of the coil.

Identify the correct fastening holes at the baseplate as seen here. There are 2 sets of them, one used for all JAWA models.



Put the base plate (consisting of the outer steel ring and the inner aluminium plate) into the place of your old generator.

The sensor should show into a 10 o'clock position, the stator coil will hang loosely.

Make sure to use the right set of fastening holes and screw the plate with the help of the 2 countersunk screws M6x30 (CZ and Perak M6x40) down.



Put the stator coil back onto the plate, take care not to damage the wires.

Make sure that the inner opening of the stator unit slots evenly over the elevated fixing rim of the base plate - otherwise the coil will sit lopsided and will touch the rotor, damaging it.

Screw the coil down with the 3 hex screws M6x30 and tighten.



Under no circumstances effect mechanical changes on your engine casing in order to fit the system (save for pulling or breaking the pin at the stator base). Do not try to assemble the new stator without the steel ring, even if you think temporarily that fitment may only be achieved that way. This comes from a wrong assumption that the stator should be fitted right down to the bottom of the engine casing. The new system will sit, as the old one did, in the recesses a little higher up.



Place the rotor drum onto the crankshaft, taking care to fit the slot onto the roller pin of the crank. Check that the rotor sits well on the shaft. It happens that a roller pin is a little too high and prevents good fitment. In that case take a little material of the roller.

Check further, that the rotor runs freely above the base plate.

Tighten the rotor with the screw M6x40, not forgetting the supplied washer. To undo the rotor use a puller M27x1,25.

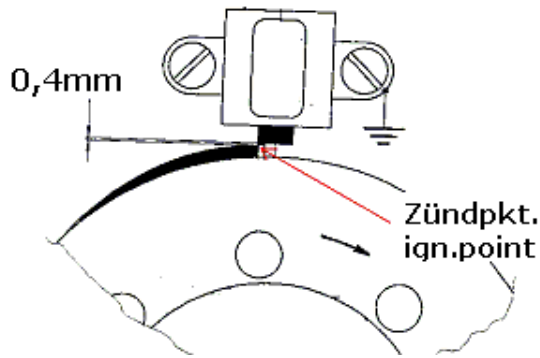

Turn the rotor slowly by hand and check clearance between the sensor and one of the rotor noses. This has to be ca. 0,4mm. You may adjust the gap by loosening the 2 holder screws of the sensor and shifting it a little. Do not forget to tighten the 2 holder screws of the sensor carefully. If loose, the sensor will get into contact with the rotor and will be destroyed. It is a good idea to check secure fitment from time to time.



Mount the regulator/ rectifier unit of your MZ-B-Tronics at a convenient place (say [on the inner outside of the tool box](#)).

Afix the relay (so you use this option).
Proposition is next to the battery.





Fasten the new ignition coil at the place the old coils have been. We provide some holder with screws that should enable you to fit the coil there. To use this, fit the coil with its HT exits facing backwards (towards the seat). Unfortunately the stock coil fastening hole in the frame seems to have been drilled at random, so our holder will not always fit without modification, even though we have provided oblong holes.

Please note: All our 6 Volt systems do not support the charge control function!

Connect the parts as shown in [wiring diagram 72xr6](#):

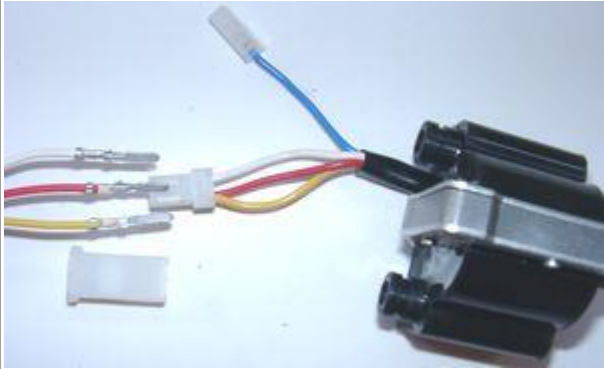
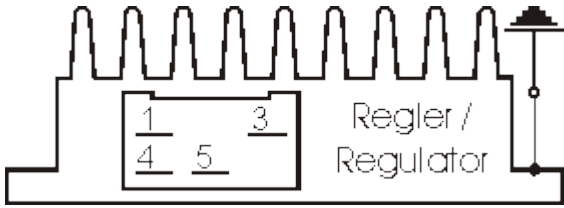
* To facilitate wire exit through the often small openings in the engine casing, the plastic plug of the generator's wiring that leads to the ignition coil have not been put onto the wire terminal. You should place the plug there only once all has been properly installed on the engine side.

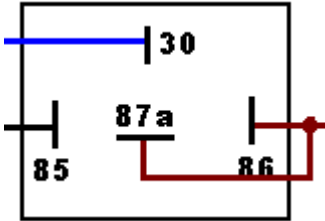
	<p>Look for the ignition coil with its female plug and the three wires (red, yellow and white).</p> <p>Put the provided 4-position plug housing onto this plug and insert the three wires (red, yellow and white) from the generator. Make sure that the terminals engage securely in the housing and that you connect:</p> <ul style="list-style-type: none"> • red to red • yellow to yellow • white to white
<p>Should you need (or want) to get the terminals out of the plug housing again, enter a paper clip from front next to the terminals and push the little barb aside. Than pull the wire out.</p>	
<p>*</p> 	<p>The regulator/rectifier has a compact plug with 6 positions, of which two are not used. A female plug cover fitting to this plug is delivered. Into this female plug you have to insert the following wires (which have terminals that snap into the plug):</p>
<p>The two black cables leading from the generator ...</p>	<p>... connect to pins 1/4 of the new regulator (from there equally black wires lead inside the unit). It does not matter which wire connects to which of the both terminals (1/4) as they carry alternating current.</p>
<p>The new brown cable with the round eye terminal ...</p>	<p>... connects pin 3 of the regulator unit (from there a <i>white</i> wire goes inside the unit) with the negative pole of the battery or (in case you drive without battery) to ground (chassis).</p>
<p>The new red cable with the round eye terminal ...</p>	<p>... connects to pin 5 of the new regulator (from there equally a red wire goes inside the unit). Here your regulated positive voltage comes out to connect to battery plus, or (in case you drive without battery) to the voltage input terminal of the main switch (ignition lock, German bikes: pin 51/30).</p>
<p>Make sure that you have a 16A-fuse between battery and vehicle circuitry.</p>	
<p>The 6 Volt regulator has NO provision for a charge control light!</p>	

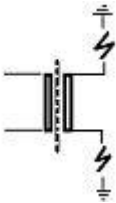
<p>Remains the blue (sometimes blue/white) wire at the ignition coil. This is the kill (cut-off) wire.</p> <p>* Connected to ground - it will stop ignition!</p> <p style="text-align: center;">Note:</p> <p>Should you experience ignition failures, disconnect as a first measure this blue wire. In many cases that will permit you to get mobile again (particulars see: technical help!)</p>	<p>Switch off via separate kill switch (when driving without battery): The relay will not be fitted. The blue(/white) cable of the ignition coil will be connected to a kill switch, closing against ground (a button at the handlebars). Or you mount an ignition lock that has a facility to connect against ground when in OFF position.</p> <p>Battery method: Connect the brown relay wire to good ground. Lead the longer black wire from the relay to the wire that did run previously to a pin carrying voltage when the switch is on (in German bikes: pin 15) and connect it there. Connect the blue wire from pin 30 of the relay to the blue(/white) wire at the new ignition coil. should your battery fail on the road, just disconnect that blue wire and your bike will run again (it will now only not stop by switching off).</p>
<p>Relay wiring (if used):</p>	 <p>The brown wire with the ring terminal from pins 87a und 86 goes to ground.</p> <p>The black wire from pin 85 goes to a main switch terminal carrying voltage if switched on.</p>
<p>* </p> 	<p>In our twin outlet coils both ends of the secondary go to the spark plugs.</p> <p>Typical resistance between both exits is 6.2kOhm. Both exists fire at the same time (as many twin systems do). Sparks will be polarised however at a 180 degrees difference which might manifest when you strobe it.</p>
<p>Ignition will only work correctly if both plug terminals are connected. You may not test one side with the other open (not sitting on the mounted spark plug). This is because (effectively) each exit uses ground from the other. That means also that both plugs are working in serial, adding resistances, so better use low resistance spark plug (resistor) sockets and make sure they are good. If in doubt, measure resistance on a hot socket (warm it up before measuring).</p>	

<p>Is the flow from ground of one side via spark plug there, via coil, to the other spark plug and its ground interrupted you get no spark - on neither side. If you really want to test only one side, put the HT wire of the other to ground (earth it) than it will work. Sometimes a coil deprived of its ground from the other side searches for a substitute - with some solid fireworks around it to the chassis.</p>	
<p>Screw the high tension (ignition) cables ...</p> <p>* Please don't use any spark amplifying cables, such as "Nology supercables" ("hot wire"), it will leads at VAPE systems to problems and may even causes damage to the electronic system.</p>	<p>... into the ignition coil and pull over the rubber seals before mounting the coil (it will be easier).</p> <p>Please do use the cable arriving with the pack and not any old cable.</p>
<p>You will do yourself a favour to treat your bike to new spark plugs and spark plug sockets (preferably some between 0-2kOhm). Plenty of problems are lead back up to "apparently good" (even completely "brand-new") sparks plugs, terminals and cables. Do not use spark plugs with an intern suppression resistor. NGK (e.g.) offered such spark plugs coded with an "R" (for resistor).</p>	
<p>Finally - and before installing the battery and before the first kickstart - please re-check carefully all connections and fitments against the wiring diagram.</p> <p>* Should something not work, please consult our trouble-shooting guide on our homepage. As a first step disconnect the blue wire from the coil and re-test.</p>	
<p>* IMPORTANT: During crank shaft repair the dynamo shaft is often machined and gets shorter. The result is a rotor sitting lower, possibly touching now with its rivets the stator coil. The result is a destroyed stator and ignition failure. For more detail and how to check see (online) here.</p>	
<p>Important safety and operating information</p>	
<p>Safety first! Please observe the general health and safety regulations motor vehicle repair (MVR) as well as the safety information and obligations indicated by the manufacturer of your motorcycle.</p> <p># The timing marks on the material are for general guidance only during first installation. Please check after assembly by suitable means (stroboscope) that settings are correct to prevent damage to the engine or possibly even your health. You alone are responsible for the installation and the correctness of settings.</p>	
<p># <u>Ignition systems generate high tension!</u> With our material right up to 40,000 Volts! This may, if handled carelessly, not only be painful, but outrightly <u>dangerous</u>. Please do keep a safe distance to the electrode of your spark plug and open high tension cables. Should you need to test spark firing, hold the spark plug socket securely with some well insulating material and push it firmly to solid ground of the engine block. Never pull sparkplug caps when engine is running. Wash your vehicle only with engine at standstill and ignition off.</p>	

#	Should you have received in the kit HT cables with a fixed rubber boot(which does not contain a resistor) you might have to use spark plugs with an inbuilt resistor (or replace the cap with one containing a resistor) to comply with your local laws.
#	After installation, please <u>check tightness of all screws, even those preinstalled</u> . If parts get loose during run, there will be inevitably damage to the material. We pre-assemble screws only loosely.
#	Give the newly installed system a chance to work, <u>before you start to check and test values</u> , or what is worse apply changes to it. Our parts have been checked before delivery to you. You will not be able to check much anyway. At any rate do refrain from measuring the electronic components (such as ignition coil, regulator and advance unit). You risk severe damage to the inner electronics there. You will not get any tangible results from the operation anyway. Bear in mind that also your carburetor, your spark plugs and spark plug sockets (even if completely new) might be the reason for malfunction. The general experience with our systems is that the carburetor will have to be re-adjusted to lower settings. Should the system not start after assembly, first disconnect the blue (or blue/white) cut-off wire directly at the ignition coil (or in some cases advance unit) to eliminate any malfunction in the cut-off circuitry. Check ground connections carefully, make sure there is a good electrical connection between frame and engine block. In case of troubles, please consult our Knowledge Base first before you send off the material to us for checking
#	The spark of classic, points based ignition systems has with about 10,000 Volts comparatively little energy and looks therefore yellow and fat (which however makes it highly visible). The spark from our system is a high energy spark with up to 40,000 Volts and therefore is needle thin focused in form, and blue in colour, which makes it not so visible. Furthermore you get spark only at kick-start operated speeds and not by pushing the kick-lever down slowly with your hand (as you might get with battery based ignitions).
#	Systems using a <u>twin outlet ignition coils</u> have a few peculiarities. Please observe that during tests on one side, the other has either to be connected to an fitted spark plug or securely earthed/grounded. Otherwise there will be no spark on either side. Also with such open exits long and dangerous sparks may fly all over the coil.
#	Never do electric arc welding on the bike without completely disconnecting all parts containing semiconductors (ignition coil, regulator, advance) stator and rotor need not be taken off. The same is true for soldering. Before touching electronics disconnect the soldering iron from mains! <u>Never use copper putty on spark plugs.</u>
#	Electronics are very sensitive to wrong polarity. After work on the system, do check correct polarity of the battery and the regulator. Wrong polarity creates short circuits and will destroy the regulator, the ignition coil and the advance unit. As a rule, wiring will always be colour to colour. Instances, where colour jumps between wires are expressly mentioned in our instructions.
#	When you handle the new rotor, take care not to damage its magnets. Refrain from direct blows to the circumference of the rotor. When transporting never put the rotor over the stator. <u>Observe our information relative to transport of the material.</u>

#	Do not use spark plug sockets with a resistance of more than 5kOhm. Better use 1 or 2kOhm ones. Bear in mind that spark plug sockets do age and thereby increase their internal resistance. Should an engine start up only when cold, a defective spark plug socket and/or spark plug is very probably the cause. In case of problems check high tension cables too. Never use carbon fibre HT-cables, never use so called "hot wires" which promise to increase spark.
#	It is a good idea to cover the rotor in a thin layer of oil to reduce the risk of corrosion.
#	Never use a claw puller or a hammer to disengage the rotor. Its magnets might become loose in the event. We offer a special puller for disengaging the new rotor again (see assembly instruction)!
#	Should the motorcycle not be in use for some longer period, please disconnect the battery (so existing) to prevent current bleeding through the diodes of the regulator. Though, even a disconnected battery will empty itself after a while.
#	Please do observe these remarks, but at the same time, don't be afraid of the installation process. Remember, that before you, thousands of other customers have successfully installed the system. <i>Enjoy driving your bike with its new electric heart!</i>